



## Walk-in Coolers & Freezers

Foodservice • Refrigerated Warehouse • Refrigeration Systems



## Kolpak: Protecting Your Future

As a foodservice professional, you make a promise to every customer who walks through your door. A promise to protect the quality of your food and service, day and night. That's why we're dedicated to instilling that trust right at the center of your organization, so you can confidently provide your guests with nothing but the absolute best.

Working with restaurateurs for over half a century, we've devoted ourselves to creating products and solutions that can withstand all the pressures of your fast-paced establishment. With their unparalleled reliability, you can count on our walk-in units to provide the "day-in-and-day-out" support you need, right at the foundation of your enterprise.

We take special care to reflect that essence of dependable integrity in every one of our designs. With their straightforward simplicity, our walk-ins are easy to learn, use, and maintain, keeping you up and running from the very start. And by streamlining your workflow from the ground up, you'll appreciate an efficiency that spreads throughout your entire kitchen.

We know you've got your sights set far beyond today. That's why we provide your restaurant with the solid footing you need to keep your eyes confidently on the future. No matter where you're headed, you can count on Kolpak as a genuine partner to help you get there.



We have the best lead times in the industry: 10 to 15 days!  
In addition to the following...

### FLOOR DESIGN OPTIONS

Kolpak's patented Era bracketed technology offers greater floor strength for foot traffic and rolling carts, approved for up to 1,000 lbs. per sq. ft. uniform load that is built to last and eliminates floor delamination, avoiding the walk-in down-time. The Era bracket eliminates the need for plywood underlay on foot traffic floors while enhancing its ability to handle light rolling cart traffic. The design without plywood continues to meet NSF and DOE requirements. The Kolpak Era bracket on structural floors with 3/16" overlay provides superior strength needed for keg coolers and other heavy rolling carts.

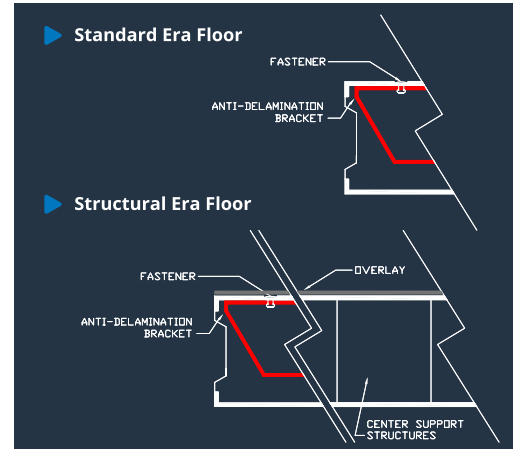

Kolpak offers Era bracket flooring in a variety of finishes designed to fit your loads

### ENERGY EFFICIENT HARDWARE

Adjustable hinges allow for field adjustability to ensure a tight seal keeping your walk-in at the temperature it needs to be.

### AIR SHIELD

Designed to mount vertically, adjacent to the walk-in door on the interior wall surface, the Air Shield features an innovative air delivery system that channels a barrier of refrigerated air which

flows horizontally across the interior side of the door opening. The Air Shield is automatically activated when the door is opened and shuts off when the door closes significantly reducing the amount of warm air infiltration into the refrigerated space (keeps the cold air in and the warm air out).



Kolpak's optional Air Shield reduces air infiltration whenever the door is open

### KOLPAK REFRIGERATION

The Kolpak Scroll Series Remote Refrigeration System is available in single units or racks; water or air-cooled. All units are now more energy efficient than ever with scroll compressors, ArcticFox LDA, and R448A refrigerant.



Kolpak Polar-Pak Refrigeration System makes installation as simple as attaching a pigtail and plugging the unit into the wall. No drain line is required on indoor installations. R404A refrigerant. All Kolpak Refrigeration is designed especially for foodservice applications.

## Polar-Pak Walk-ins

### WALK-IN TO CONVENIENCE

Polar-Pak coolers and freezers consist of the same rugged, high performance construction that has made Kolpak the leader in walk-in refrigeration. Polar-Paks can be used in any configuration without the need for numbered panels.

The Polar-Pak modular panels of 4" 100% foamed in place non-CFC urethane foam offers superior insulating capabilities. The exterior and interior of top-quality galvalume metal offer an attractive and rugged finish.

Polar-Pak is the industry's simplest installation. There's no need for a refrigeration technician or a plumber and offers superior air circulation around the coils making it both economical and efficient to run.

Newly designed, patented Era bracket floor for foot traffic and rolling carts, approved for up to 1,000 lbs. per sq. ft. uniform load for improved reliability.



#### STANDARD FEATURES

- Top-mount refrigeration is flush to the interior
- Indoor and outdoor applications
- Posi-Loc panel fasteners for a perfect airtight fit
- Adjustable hinges and durable handle
- Superior door construction to seal in cold, prevent condensation
- Interior safety release to prevent accidental entrapment
- Coved corners on floor panels for easier cleaning, greater sanitation
- Heated air-vents on freezers to eliminate vacuum and pressure build-up.
- LED interior light with safety night light
- Available in both top-mount and side-mount models
- Some standard 7' 6 high unit are part of our Polar-Pak Quick Ship program, ship within 48 hours after your order has been received

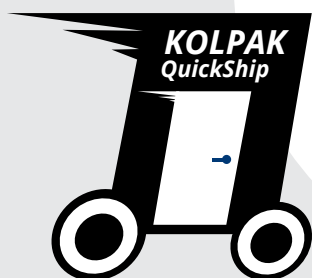

## KoldFront Walk-ins

WALK-IN TO FLEXIBILITY

When you require a walk-in for an installation with greater flexibility, Kolpak KoldFront is the solution. Made from the same quality panels and components Kolpak is renowned for, the Kolpak KoldFront solution features Rapid-Ship components that are ready to assemble. Compartment sizes available 6' x 8' to 12' x 22' in 2' increments. 7'6" or 8'6" panel heights and single or two compartment options are available. This results in faster ship times and a potentially more cost-effective solution depending on your exact requirements. Indoor application only.



### STANDARD FEATURES

- All models are Rapid Ship, ship with five days after your order has been received
- Cam locks ensure panels lock to a rigid air-tight seal
- Door hinges are adjustable to ensure a square air-tight seal for greater energy efficiency
- LED door section light with safety night light
- Heated air-vents on freezers to eliminate vacuum and pressure build-up.
- 36" high door plug kickplates interior and exterior
- Easy to adjust digital temperature control
- Pre-Charged Scroll Series Refrigeration systems in R448a refrigerant giving you an available 1-year parts and labor enhanced warranty
- ArcticFox® LDA included
- Newly designed, patented Era bracket floor for foot traffic and rolling carts, approved for up to 1,000 lbs. per sq. ft. uniform load for reliability

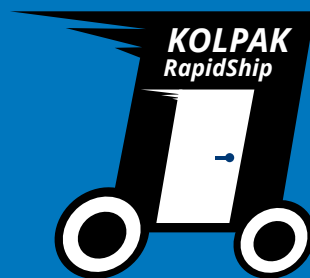

## Custom Walk-ins

### WALK-IN TO ALL YOUR CUSTOM NEEDS

Kolpak custom walk-ins use all the components that have made our walk-ins famous for quality, flexibility, and reliability. Kolpak is energy-efficient and an innovation leader that provides maximum cold holding performance. We manufacture panels in 4", 5", and 6" thick options in Softnose construction configurations. We designed to precise specifications in a wide variety of configurations, shapes, and material from large to small with many options available.



### BUILT-IN EFFICIENCY

When you choose Kolpak Custom Engineered you can rest assured that we have not cut any corners when it comes to the performance of your walk-in.

### STANDARD FEATURES

- Manufactured to any size and shape you need
- Cam locks create a rigid air-tight seal between panels
- Fully adjustable hinges for the best possible gasket seal
- LED Lights are energy-saving and long lasting
- LED door section light with safety night light
- Coved corners on floor panels for easier cleaning, greater sanitation
- Heated air-vents on freezers to eliminate vacuum and pressure build-up
- Easy to adjust digital temperature control
- Single and 3 phase Pre-Charged Scroll Series refrigeration systems in R448a refrigerant giving you an available 1-year parts and labor enhanced warranty
- ArcticFox® LDA included
- Newly designed, patented Era bracket floor for foot traffic and rolling carts, approved for up to 1,000 lbs. per sq. ft. uniform load



## Walk-in Renovation Options

LET KOLPAK KEEP YOUR INVESTMENT FUNCTIONING AT ITS BEST

### BOLT OVER DOORS

The doors on your walk-in take the most abuse over time. If your walk-in is in good shape, but the door has seen better days, we can have a door and frame manufactured to bolt directly over the existing opening. The original door plug is removed and all your electrical accessories are pulled through and



mounted on a brand-new door, complete with new hinges and door handles. It doesn't even have to be a Kolpak walk-in. We can retrofit any manufacturer's box.

### FLOOR OVERLAY & DROP-IN FLOORS

Kolpak offers several ways to install new flooring into your walk-in. If your floor is



delaminating, Kolpak can overlay to give you a new surface. Our certified installers can also cut out your original floor and install a brand new "drop in" floor.

### WALL AND CEILING BATTENS

Kolpak offers metal wrapped insulation battens. These insulated battens help prevent air infiltration by covering and reinforcing seam gaps on wall and ceiling panels.

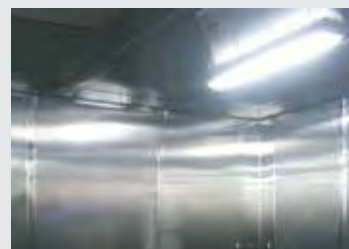

## ArcticFox®

TOTAL COOLING CONTROL & EFFICIENCY

### ARCTICFOX WIFI OEM CONTROLLER



- ▶ Remote monitoring via WiFi connectivity
- ▶ Notification by "text / e-mail messaging" for Alarms / Alerts
- ▶ Monitor or adjust using smart phone / tablet / computer
- ▶ ArcticFox WiFi refrigeration maximizes performance range on the hottest days

### SMART-PAK ADVANTAGE

Provides the maximum cold holding performance with the minimum environment impact, all while saving you money on energy costs, operating costs, and overall cost of ownership. This ultimate energy saving walk-in package can reduce your energy consumption by up to 50% during normal use by taking advantage of the energy savings of ArcticFox® OEM Demand Defrost controls with WiFi, the Kolpak Air Shield, standard LED lighting and the fully adjustable door hardware package (available standard, brushed, or polished finish)

### IMPROVED TEMPERATURE STABILITY WITH TRU-DMND® DEFROST

- ▶ Demand defrost initiates defrost cycles only when needed
- ▶ Avoids up to 93% of standard system defrost cycles
- ▶ Fewer defrost cycles improves temperature stability in the box
- ▶ Fewer defrost cycles allows less temperature fluctuations during typical operation
- ▶ Tighter temperature control provides a safer environment for product
- ▶ Less defrost cycles increases shelf life of products due to less temperature changes

### UP TO 30% ENERGY REDUCTION

- ▶ System pays for itself in as little as 2 years (depending on system size)
- ▶ Diagnostic aid by providing Data Logging
- ▶ Notification of Alarms / Alerts by text or e-mail
- ▶ Remote monitoring via WiFi on smart phone / tablet / or computer
- ▶ Remote viewing of "Dash Board" with system status
- ▶ Control manages Evaporator Fans and Defrost Heaters
- ▶ Reduces potential for steaming during defrost by controlling heater temperature rises



The next generation walk-in controller with Tru-Dmnd® defrost



## Let us floor you!

### WIDE OFFERING OF FLOOR OPTIONS

#### KOLPAK ERA FLOOR

Kolpak's patented Era bracketed technology offers greater floor strength for foot traffic and rolling carts, approved for up to 1,000 lbs. per sq. ft. uniform load that is built to last. The Era bracket eliminates the need for plywood underlay on foot traffic floors while enhancing its ability to handle light rolling cart traffic. The design without plywood continues to meet NSF and DOE requirements. The Kolpak Era bracket on structural floors with the addition of 3/16" overlay provides superior strength needed for keg coolers and other heavy rolling cart loads up to 5,000 lbs. per sq. ft. uniform load.

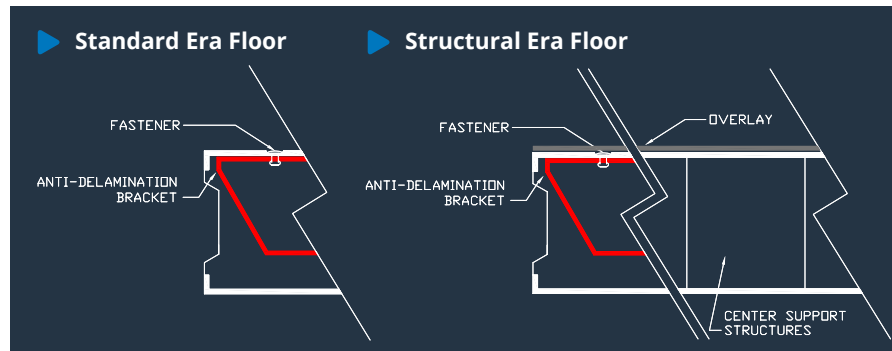

The design without plywood continues to meet NSF and DOE requirements. The Kolpak Era bracket on structural floors with the addition of 3/16" overlay provides superior strength needed for keg coolers and other heavy rolling cart loads up to 5,000 lbs. per sq. ft. uniform load.

#### METAL SCREED

Available for all applications, 4" to 20" high. Metal screeds are used in situations where the screed finish must match the wall finish, seismic, or outdoor applications. Metal screeds consist of metal surfaces with urethane insulation (sandwich-type construction). The screed would require coving to be installed in the field after installation. Installation involves fastening the screeds to the building floor with the fasteners provided or with other suitable fasteners.

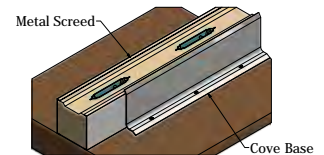

#### VINYL SCREED

Used in indoor cooler applications where a level floor entry into the walk-in is necessary. The four-inch high foamed plastic screed is normally used to adapt a floorless cooler compartment to the standard floor of a freezer compartment. This combination provides an insulated regular floor in the freezer compartment and floorless application in the cooler compartment. The screed consists of a vinyl extrusion with urethane insulation between the vinyl to insulate and add rigidity. There is a flexible covered lip on both sides of the screed for easier cleaning and greater sanitation. The screed has factory-installed clips to allow the wall panels to be locked in position.

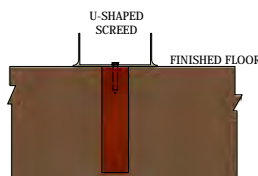
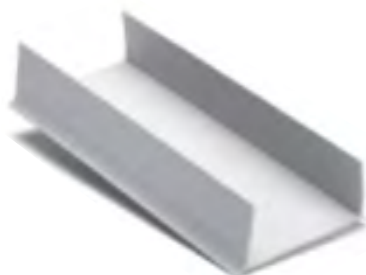
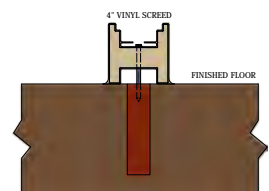

## Simplicity in Operation

Kolpak offers a variety of the most energy efficient hardware and accessories to fit your walk-in cooler or freezer needs.

### LED LIGHTS

Energy saving LED lighting options designed for damp, wet, walk-in coolers or freezers applications are available from Kolpak.

In addition to the energy savings, these fixtures also save money on bulb replacements rated for 50,000+ hours of life.

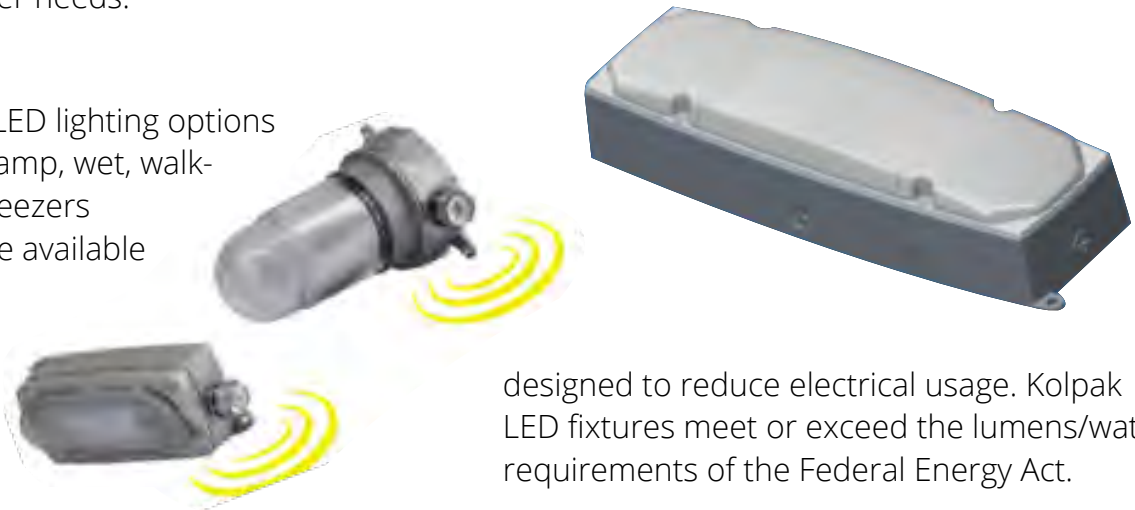

designed to reduce electrical usage. Kolpak LED fixtures meet or exceed the lumens/watt requirements of the Federal Energy Act.

All Kolpak door section lights are LED and include a constant burn, low wattage LED nightlight that is always illuminated for safety even when the main lights are turned off.

Kolpak's 1809 LED compartment light fixture is low profile, compact in size, with up to the same lumen as the 4' fixtures. Fixtures include Lexan lens with anti-glare technology



### ALARMPAK®

Offers energy savings, food safety, and alarms in one convenient package

### SWITCH/DIGITAL THERMOMETER COMBO

This one device has a touch sensor light switch, a digital thermometer, a transformer built in, a weatherproof polycarbonate face, an option to connect a 9V battery, and an option to connect a second temp probe to display two compartment temps. Comes standard with 3' lead. 20' lead available.



#### Performer Advantage/Polished/Brushed hardware



**Kason 1094 Hydraulic Actuated Door Closer**  
1 1/2" long gauge steel mechanism and hook. Available in polished or brushed finish.

**Kason 1346 Radius Style Hinge**  
Die cast flange and stop with stainless steel. Auto close, spring-assist. Available in polished or brushed finish.

**Kason 27C Deadbolt Locking Handle**  
Die cast handle and strike with glow in the dark night safety release. Pad lockable. Available in polished and brushed.

#### Performer Advantage/Polished/Brushed hardware



**Kason 1098 Spring Actuated Door Closer**  
Plated steel mechanism and hook with a dark grey ABS cover.

**Kason 1345 Radius Style Hinge**  
Positively adjustable hinge with a die cast aluminum flange, die cast hinge with a die cast grey ABS cover. Auto close and spring assist.

**Kason 28C Deadbolt Locking Handle**  
Structural steel tube, steel strike with a die cast grey ABS cover to provide optimum strength and durability with glow in the dark night release. Pad lockable.

## Long-Lasting Ceilings

Kolpak delivers rugged performance for indoor and outdoor walk-ins with combined resources with a tradition of excellence in highest quality construction and reliability.

### SUSPENDED CEILING

Used where the existing building will support the load of the walk-in ceiling, this leaves a clean, unobstructed enclosed area

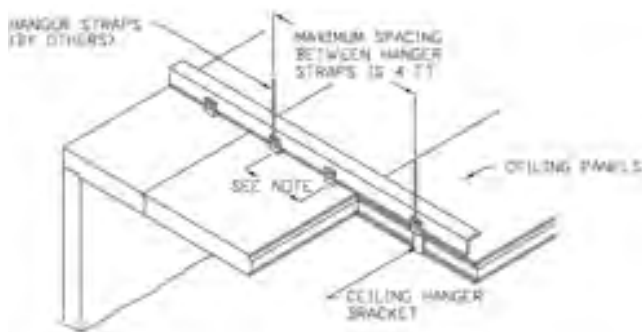
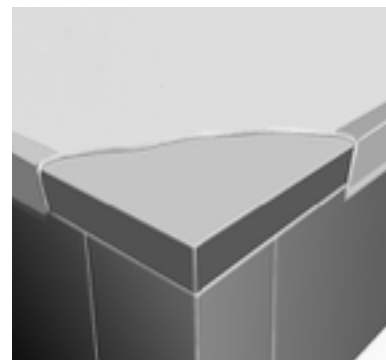

### SUPERSPAN CEILINGS

Designed for applications where heavy snowfall is a major factor to promote safety and relieve the inconvenience of post and beams

### ERA CLEAR SPAN CEILINGS

Meet the toughest structural codes without the hassle and expense of posts and beams!

- ▶ approximately twice the allowable span vs. standard ceiling
- ▶ approximately a 40% increase in allowable span vs. super ceiling
- ▶ single spans up to 20'
- ▶ 4" and 6" options

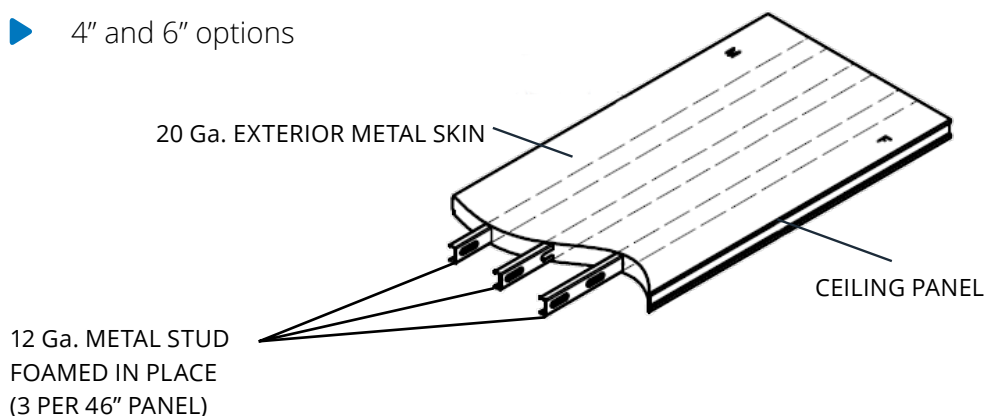

# You've purchased the best walk-in available – keep it that way with Welbilt KitchenCare®.

Welbilt KitchenCare helps service, maintain and protect your foodservice equipment and facility, throughout the lifecycle of your business. KitchenCare gives you a wide variety of options in caring for your equipment, your kitchen and even your entire facility, whether you own one restaurant or operate many. You'll feel a level of comfort you've rarely felt in a business relationship. Whether you're around the world or just around the corner our first responders are at the ready. Giving you peace of mind it will be right the first time. A well performing kitchen doesn't just happen, it takes planning, maintenance and expert know-how. Welbilt KitchenCare is all those things and more.

Every new piece of Welbilt foodservice equipment comes with KitchenCare and you choose the level of service that meets your operational needs from one restaurant to multiple units. Our network of Factory Authorized Servicers will meet your warranty and lifetime service, installation, start up and planned maintenance needs. With genuine OEM parts certified for heavy-duty use, they keep your equipment running in the most demanding kitchens.



- Warranty service
- Certified OEM parts
- 24/7 Support
- Online/Mobile Product Information



## Kolpak: Protecting Your Future

Kolpak offers a wide range of energy-saving and environmentally-friendly products and features. We've designed our units for maximum cold holding performance with minimum environmental impact, all while saving you money on energy costs, operating costs and overall cost of ownership.









Welbilt offers fully-integrated kitchen systems and our products are backed by KitchenCare® aftermarket parts and service. Welbilt's portfolio of award-winning brands includes **Cleveland, Convotherm®, Delfield®, fitKitchen®, Frymaster®, Garland®, Kolpak®, Lincoln, Manitowoc®, Merco®, Merrychef® and Multiplex®.**

*Bringing innovation to the table* • **welbilt.com**